

Features:

- Sandwich plate valve
- 4 pressure ranges
- 5 circuit options
- With one or two pressure relief cartridges
- 4 adjustment elements:
 - Rotary knob
 - Sleeve with hexagon and protective cap
 - Lockable rotary knob with scale
 - Lockable rotary knob
- Porting pattern to DIN 24 340, form A,ISO 4401 and CETOP-RP 121H



Functional, section

Pressure relief valve types ZDB and Z2DB are pilot operated and are of sandwich plate design.

They are used to limit the pressure within a hydraulic system, together with one or two pressure relief valve cartridges.

The system pressure is set by means of adjustment element (4).

At rest, the valve is closed. Pressure in port A acts on the spool (1). At the same time pressure passes through orifice (2) on to the spring loaded side of spool (1) and via orifice (3) to the pilot poppet (6). If the pressure in port A rises above the value set on spring (5), the pilot poppet (6) opens. Fluid can now flow from the spring loaded side of spool (1), orifice (3), and channel (8) into port T. The resulting pressure drop then moves spool (1), causing this to open connection A to T, while the pressure set at spring (5) is maintained.

Pilot oil return from the two spring chambers is taken externally via port T.

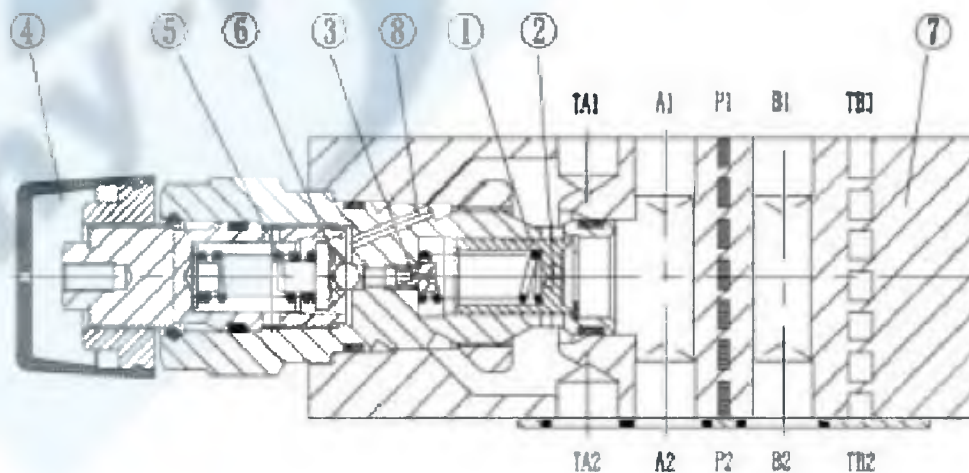

Type ZDB 6 VA2 - 40B/..

Ordering code

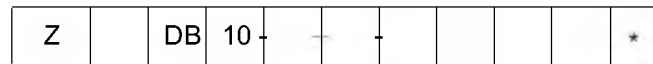

Sandwich plate = Z

Only applies to models VC and VD:
 With 1 pressure relief valve cartridges = No code
 With 2 pressure relief valve cartridges = 2

Pressure relief valve = DB

Nominal size 10 = 10

Relief function from to:

A	→	T	=	VA		
B	→	T	=	VB		
P	→	T	=	VP		
A	→	T and B	→	T	=	VC
A	→	B and B	→	A	=	VD
TB1	→	TA2	=	VT		

Further details in clear text

No code = mineral oils
 V = phosphate ester

50 = Pressure adjustable up to 5 MPa
 100 = Pressure adjustable up to 10 MPa
 200 = Pressure adjustable up to 20 MPa
 315 = Pressure adjustable up to 31.5 MPa

40 = Series 40 to 49
 (40 to 49 = unchanged installation and connection dimensions)

Adjustment element

1 =	Rotary knob
2 =	Sleeve with hexagon and protective cap
3 =	Lockable rotary knob with scale
7 =	Rotary knob with scale

Symbols

Type ZDB 10 VA ..

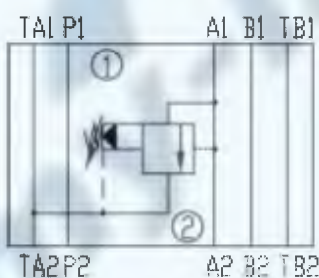

Type ZDB 10 VB ..

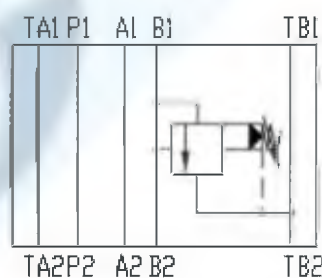

Type ZDB 10 VP ..

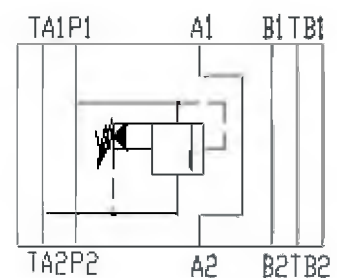

Type ZDB 10 VT ..

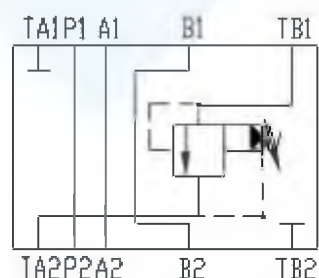

Type Z2DB 10 VC ..

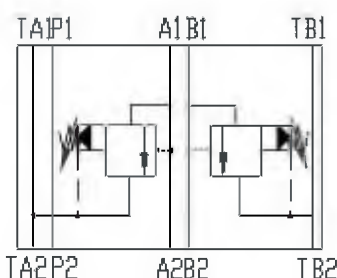

Type Z2DB 10 VD ..

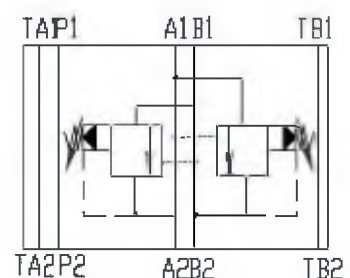

Technical data (for applications outside these parameters, please consult us!)

Pressure fluid	Mineral oil (for NBR seal), or phosphate ester (for FPM seal)	
Pressure fluid - temperature range (°C)	-30 to +80	
Viscosity range (mm ² /s)	10-800	
Degree of fluid contamination	Maximum permissible degree of contamination of the fluid is to NAS 1638, class 9. $\beta_{10} \geq 75$	
Operating pressure, max. (MPa)	up to 31.5	
Pressure adjustable, max. setting (MPa)	up to 5, up to 10, up to 20, up to 31.5	
Flow, max. (L/min)	up to 100	
Weight (Kg)	Type ZDB 10	approx. 2.4
	Type Z2DB 10	approx. 2.6

Characteristic curves (measured at $v = 41 \text{ mm}^2/\text{s}$ and $t = 50^\circ \text{ C}$)

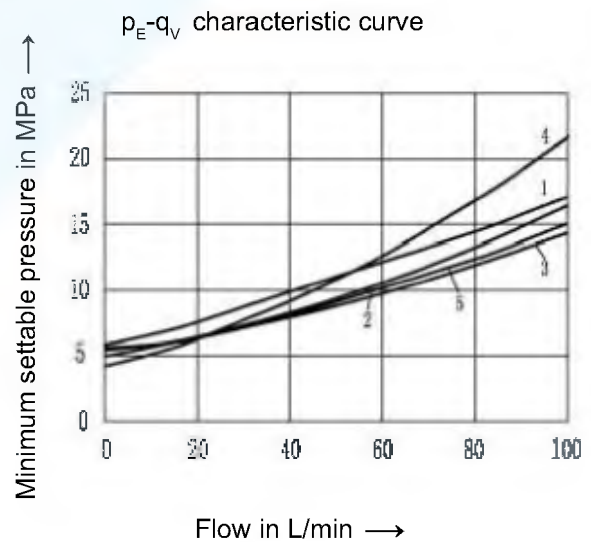
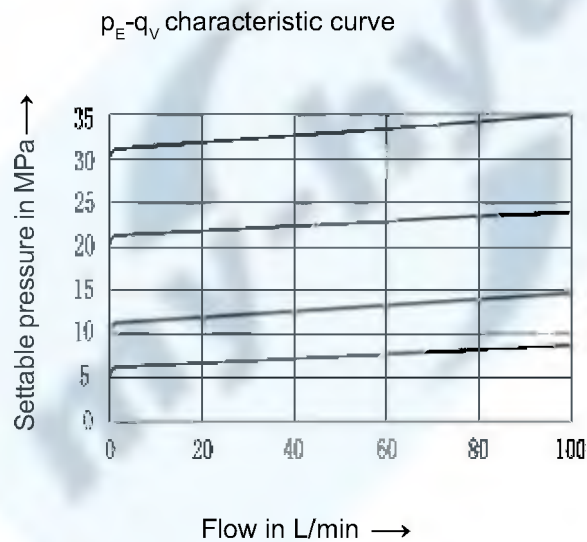

- 1 VA, VB
- 2 VP
- 3 VC
- 4 VD (A to B)
- 5 VD (B to A)

Technical data (for applications outside these parameters, please consult us!)

Pressure fluid	Mineral oil (for NBR seal), or phosphate ester (for FPM seal)	
Pressure fluid - temperature range (°C)	-30 to +80	
Viscosity range (mm ² /s)	10-800	
Degree of fluid contamination	Maximum permissible degree of contamination of the fluid is to NAS 1638, class 9. $\beta_{10} \geq 75$	
Operating pressure, max. (MPa)	up to 31.5	
Pressure adjustable, max. setting (MPa)	up to 5, up to 10, up to 20, up to 31.5	
Flow, max. (L/min)	up to 100	
Weight (Kg)	Type ZDB 10	approx. 2.4
	Type Z2DB 10	approx. 2.6

Characteristic curves (measured at $v = 41 \text{ mm}^2/\text{s}$ and $t = 50^\circ \text{ C}$)

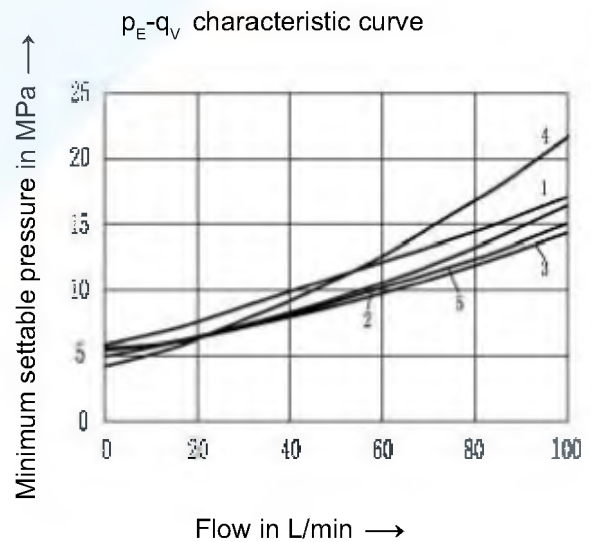
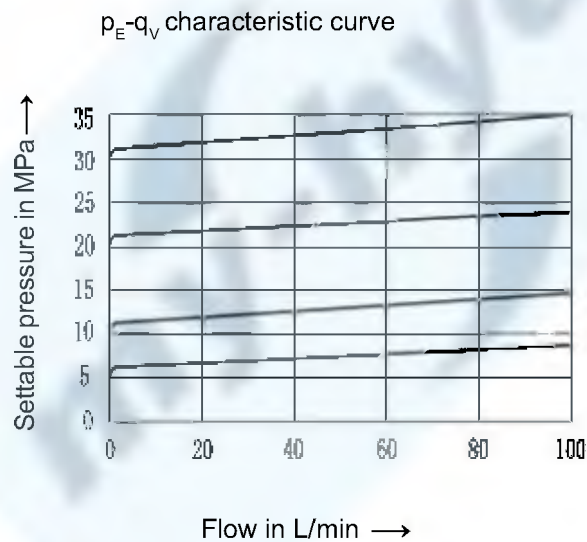

- 1 VA, VB
- 2 VP
- 3 VC
- 4 VD (A to B)
- 5 VD (B to A)

Unit dimensions: Type ZDB 10 ...-40...

(Dimensions in mm)

Type ZDB10 VA...
 Type ZDB10 VT...
 Type ZDB10 VP...

Dimensions	ZDB10	
	VA VP	VT
B	69	70
H	26	25
L1	227	218
L2	203	194
L3	117	105
L4	57.6	60.9
L5	50.3	53.6
L6	4	0.7
L7	41.5	31.8

- 1 Nameplate
- 2 Adjustment element 1
- 3 Adjustment element 2
- 4 Adjustment element 3
- 5 Adjustment element 7
- 6 Space required to remove key
- 7 Valve fixing screw holes
- 8 Lock nut 24 A/F
- 9 Hexagon 10 A/F
- 10 O-rings 12 x 2 for ports A2, B2, P2, TA2, TB2
11. O-ring plate 72 x 60 x 1.5 (only for models VA, VB and VP)
- 12 Counter bores only for models VC, VD and VT
- 13 Models ZDB 10 VA and VP
- 14 Model ZDB 10 VT
- 15 Hexagon 30 A/F, Tightening torque $M_A = 50 \text{ Nm}$

Valve fixing screws M6
 Tightening torque $M_A = 15.5 \text{ Nm}$



Required surface finish of mating piece

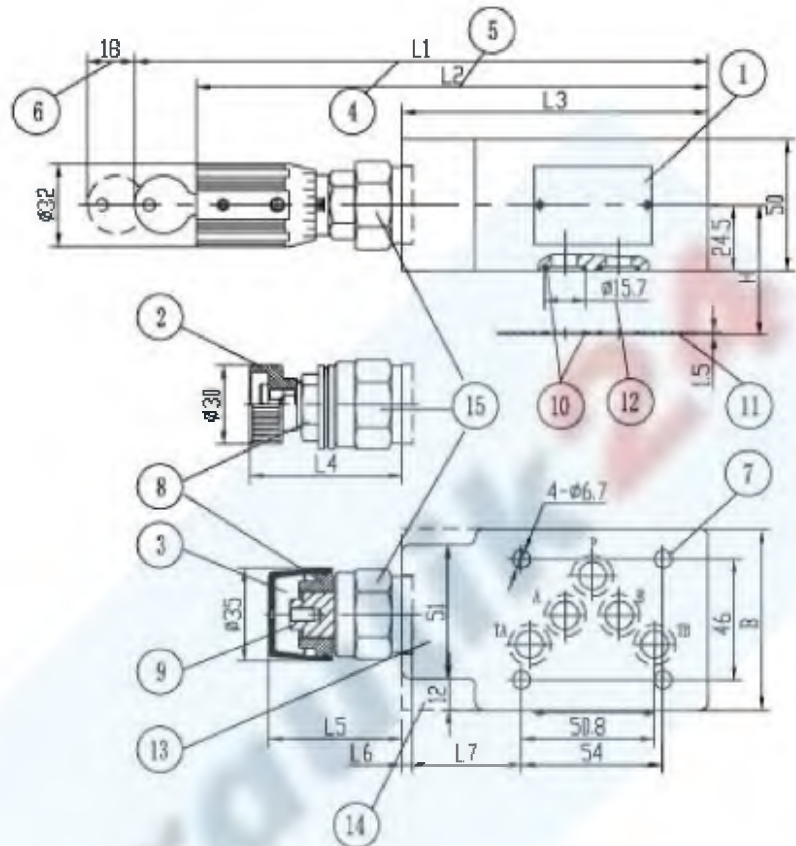

Type ZDB10 VB...

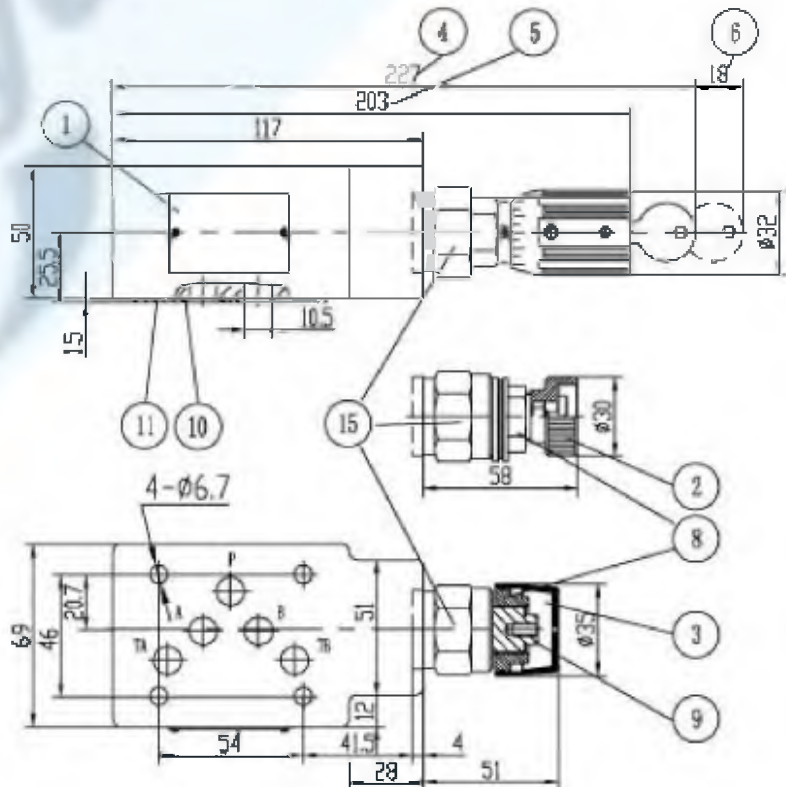

Type Z2DB10 VC...

Type Z2DB10 VD...

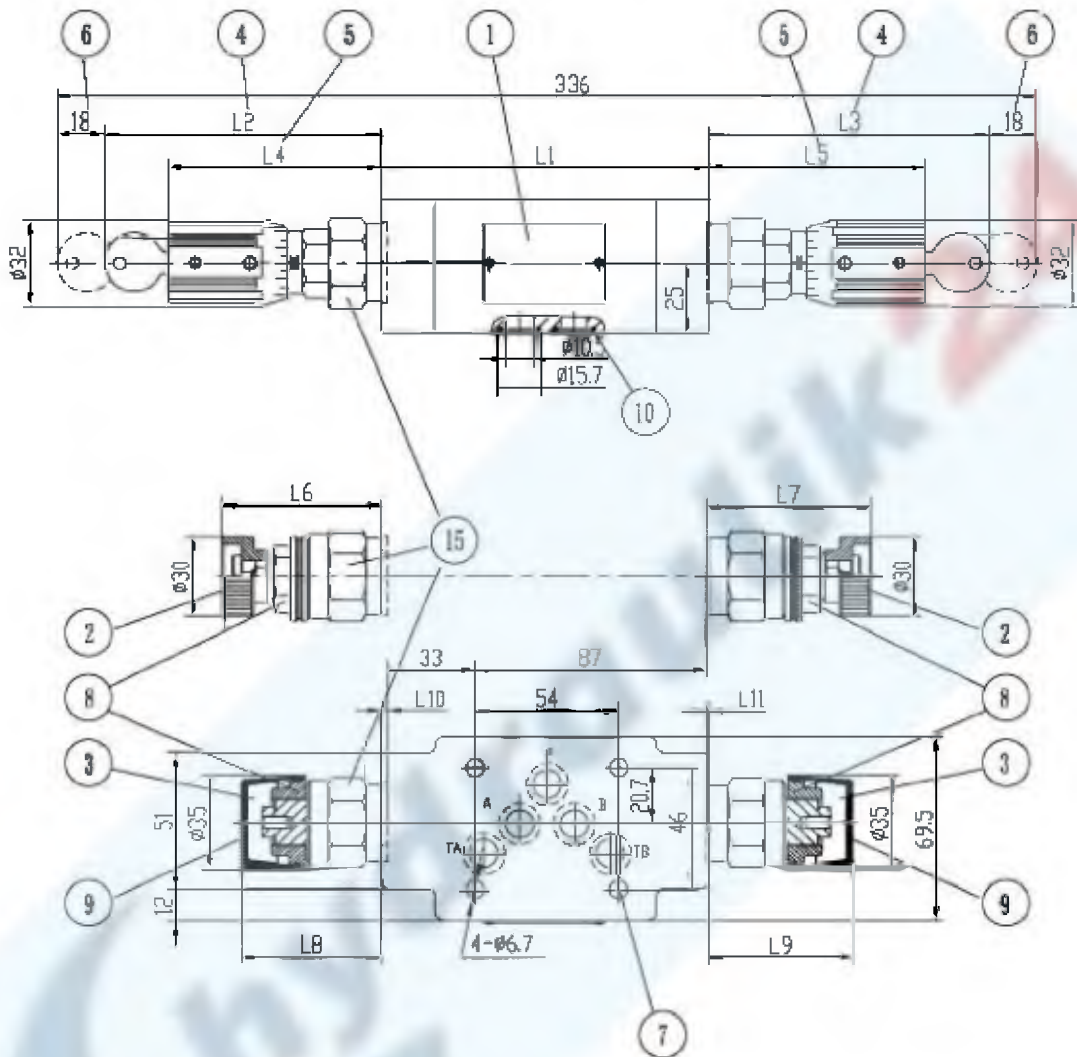

- 1 Nameplate
- 2 Adjustment element 1
- 3 Adjustment element 2
- 4 Adjustment element 3
- 5 Adjustment element 7
- 6 Space required to remove key
- 7 Valve fixing screw holes
- 8 Lock nut 24 A/F
- 9 Hexagon 10 A/F
- 10 O-rings 12 x 2 for ports A2, B2, P2, TA2, TB2
- 15 Hexagon 30 A/F, Tightening torque $M_A = 50 \text{ Nm}$

Required surface finish of mating piece



Valve fixing screws M6

Tightening torque $M_A = 15.5 \text{ Nm}$,

dimensions	Z2DB10	
	VC	VD
L1	123	132
L2	111	107
L3	112	112
L4	89	85
L5	90	90
L6	59	56
L7	60	56
L8	52	49
L9	53	49
L10	2	6
L11	1	6

NOTICE

1. The fluid must be filtered. Minimum filter fineness is 20 μm .
2. The tank must be sealing up and an air filter must be installed on air entrance.
3. Products without subplate when leaving factory, if need them, please ordering specially.
4. Valve fixing screws must be high intensity level (class 10.9). Please select and use them according to the parameter listed in the sample book.
5. Roughness of surface linked with the valve is required to $0.8 \sqrt{R}$.
6. Surface finish of mating piece is required to 0.01/100mm.